

INSTALLATION INSTRUCTIONS

VW Golf VIII R | 2020 →

EXHAUST SYSTEM:
racing gpf-back



SYMBOLS

The following symbols are used throughout these installation instructions:



TOOLS AND PROTECTIVE EQUIPMENT REQUIRED



TIGHTENING TORQUE



LUBRICATION



HAND TIGHTEN



INSTALLATION TIP



CAUTION OR IMPORTANT



MOVEMENT ARROW



INDICATOR ARROW



CERAMIC PASTE

For lubrication and corrosion protection on screws, bolts, fits and pins. Free of standard and heavy metals, prevents sticking and seizing, neutral to all known sealing materials, non toxic, up to +1400°C heat resistant, short term up to +1600°C, prevents wear and tear.



TOOLS AND EQUIPMENT

Use appropriate safety equipment like eye protection and mechanic gloves! Use appropriate and working tools for mounting and dismounting of the exhaust system.



We congratulate you on buying a product from REMUS and thank you for your trust. We are always striving to offer the very best product for your vehicle through continuous innovation processes and usage of the latest technologies.

READ THIS

Please read this entire installation manual carefully prior to installing and using the REMUS exhaust system.

REMUS exhaust system should only be installed by persons skilled in car/motorcycle exhaust system installation and performance. The instructions provided in this manual should be followed to ensure proper installation and safe use of the REMUS exhaust system. REMUS and/or its partners shall not be held liable for any damage or personal injury (including direct, indirect, or consequential damage) sustained as a result of improper installation of the REMUS exhaust system or its use and maintenance contrary to the instructions and warnings contained herein.

If you have any questions regarding the installation and/or proper use of the REMUS exhaust system or this manual, please contact your local REMUS partner.

For more information on the REMUS exhaust systems, see the official REMUS website at: <http://www.remus.eu>

GENERAL INFORMATION

Your safety is our number one priority. Please drive your car/motorcycle responsibly, safely and always obey local traffic rules.

All statements made with regard to the exhaust system's compliance are made in respect of the exhaust system "as is". Any modifications of the REMUS exhaust system or its improper installation, use or maintenance that is not in accordance with this Installation manual, may result in severe damage to the exhaust system and/ or engine, as well as personal injury, and may affect the exhaust system's compliance with the legal requirements, such as exhaust system's air and/ or noise emissions (as an example, the car/motorcycle may not be suitable for use on public roads any longer), as well as warranty coverage.

If the REMUS exhaust system is manipulated in any way, the type approval is no longer valid!

The exhaust system may only be used in accordance with relevant laws and regulations, including state and federal, where applicable.

Damage caused by improper installation, use and maintenance of the REMUS exhaust system is not covered by the REMUS warranty. Please refer to the enclosed warranty with regard to the terms of our warranty.

Technical specifications of REMUS exhaust systems and related products are subject to change without notice.



RIGHTS & NOTES

COPYRIGHT, OTHER RIGHTS NOTICE AND GENERAL NOTES

The REMUS trademark, including corporate logos and emblems, are subject to copyright as well as trademark rights of REMUS, its licensors, or third persons authorizing REMUS to use them. Any reproduction, technical or other manipulation, translation, or other use of the copyright and/or trademark rights contained herein is prohibited without the explicit prior written consent of REMUS.

The same especially applies to the entire contents of this manual and/or any of its parts, including but not limited to technical specifications, instructions, graphs, photographs, and so on included in this manual.

The photographs and other illustrations in this manual are symbolic and are intended to help represent individual steps for proper installation and use, as well as for a general overview.

The actual component parts of the REMUS exhaust system may not entirely correspond to the photographs and other illustrations.

REMUS takes all copyright and other rights infringement cases under serious consideration. If you have any reason to believe that your exhaust system is not an original REMUS product, please contact our local partners or REMUS at office@remus.at



SAFETY WARNINGS

IMPORTANT SAFETY WARNINGS, PLEASE READ CAREFULLY

The car/motorcycle should be in the off position throughout the whole dismantling and mounting process, as well as any other work done on the exhaust system!

Before dismantling the exhaust system, lock the car/motorcycle and remove the key from the vehicle to avoid electrical errors in the control units!

For proper dismantling and mounting of the exhaust system, it is recommended to use a certificated and tested lifting device.

The exhaust system can get extremely hot during and after it is used. Allow the exhaust and engine to cool down before touching it and beginning installation.

Make sure that you have all the parts necessary for the installation of your new REMUS exhaust system, according to the parts list in this manual. If any of the parts are missing, please do not proceed with uninstalling your stock exhaust system/installing the REMUS exhaust system and contact the retailer you bought the REMUS exhaust system from.

CAUTION: make sure not to injure yourself or damage any part of the vehicle during dismantling and mounting of the exhaust systems!

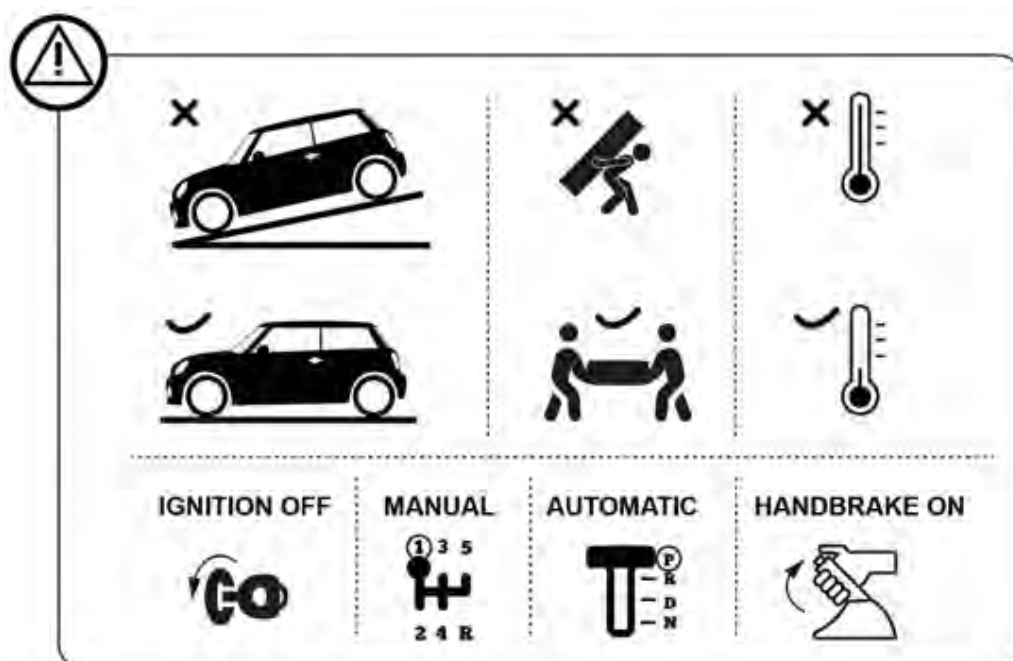

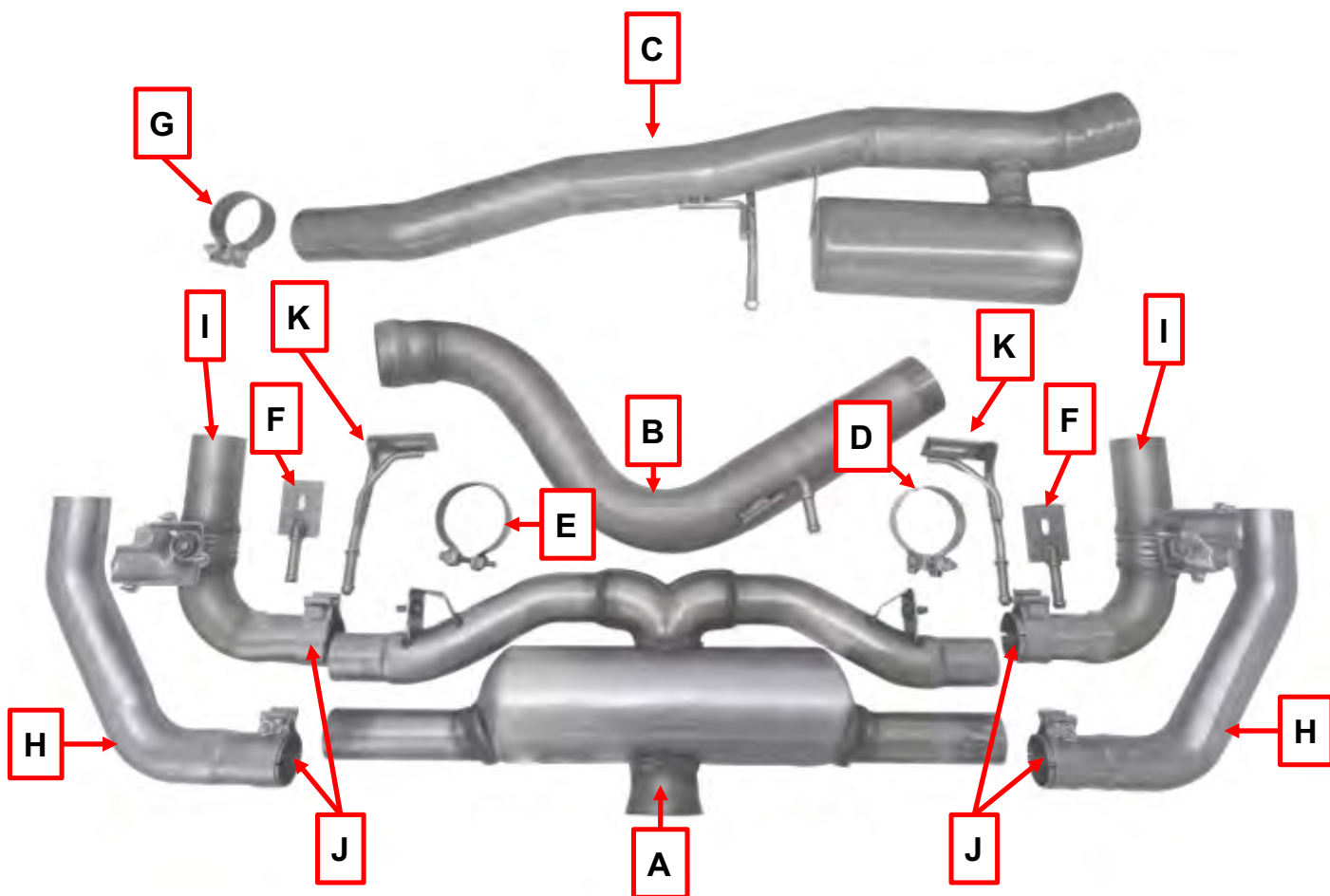

pos	pcs	packing content
A	1	sport exhaust
B	1	connection tube
C	1	front tube
D	2	clamp Ø76 mm
E	1	ball clamp Ø76 mm
F	2	body bracket
G	1	clamp Ø65 mm
H	2	outlet tube
I	2	outlet valve tube
J	4	clamp Ø60 mm
K	2	exhaust bracket
L	1	ceramic paste
M	1	pair of gloves

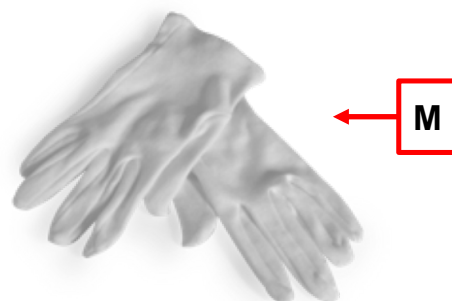

REMOVAL

OF STOCK EXHAUST SYSTEM:

The process of uninstalling the original exhaust system may vary depending on the existing exhaust system. Please follow the original exhaust system manufacturer's instructions for uninstalling the original exhaust system.

If you for any reason decide otherwise, please note that any information provided in this respect herein should be considered as general information provided for your convenience only.

REMUS shall not assume any liability or responsibility with regard to uninstalling your existing exhaust system, warranty coverage of such exhaust system or vehicle or their further fitness for use.



REMOVAL OF STOCK EXHAUST SYSTEM:

Put the vehicle onto a car lift.



CAUTION: ensure that the car is lifted safely and properly in order to avoid the risk of vehicle damage, injury, or even death!

Dismount the cross strut.

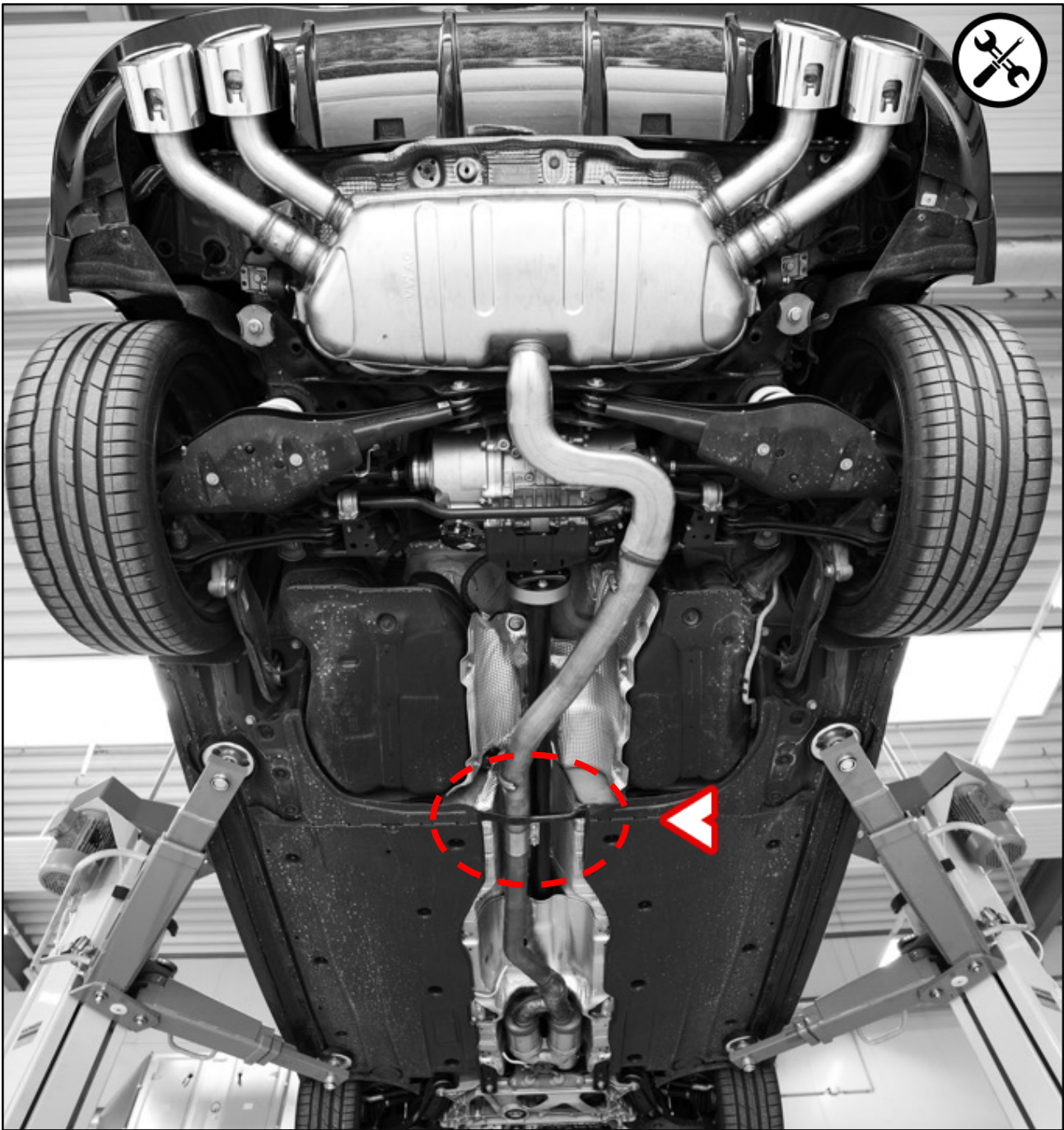

Cut the tube after the gasoline particulate filters.



CUTTING POINT: 300mm, measured at the inside of the pipe arch, beginning at the weld

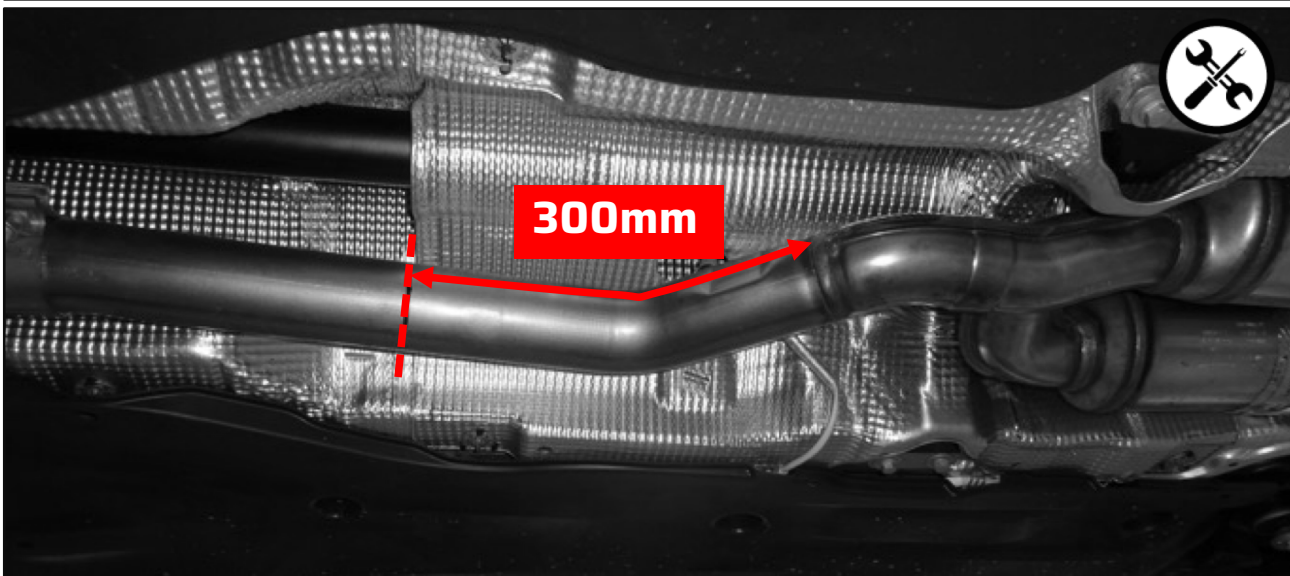
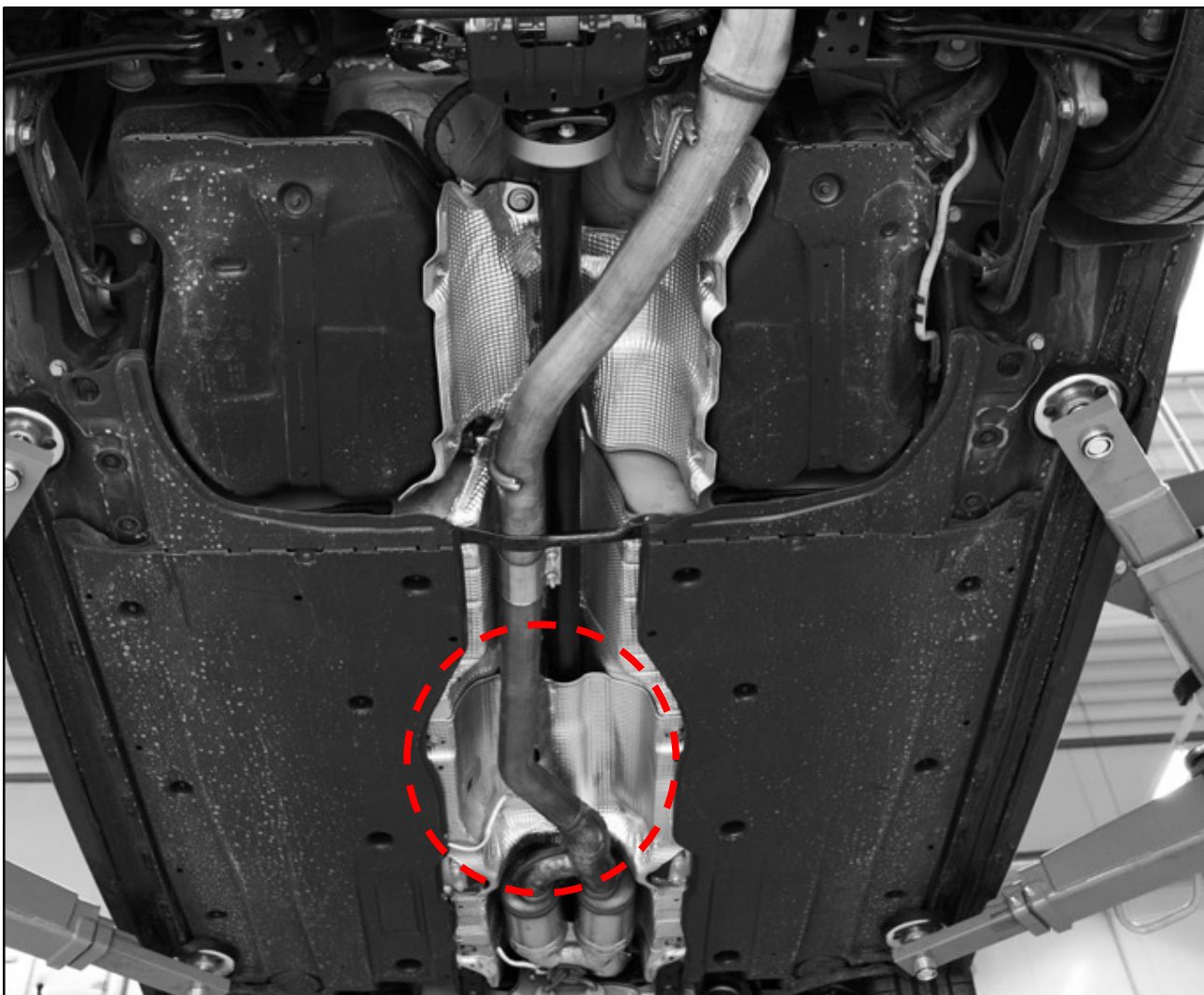

On the left and right side of the exhaust, unscrew the body brackets and disconnect the actuators.

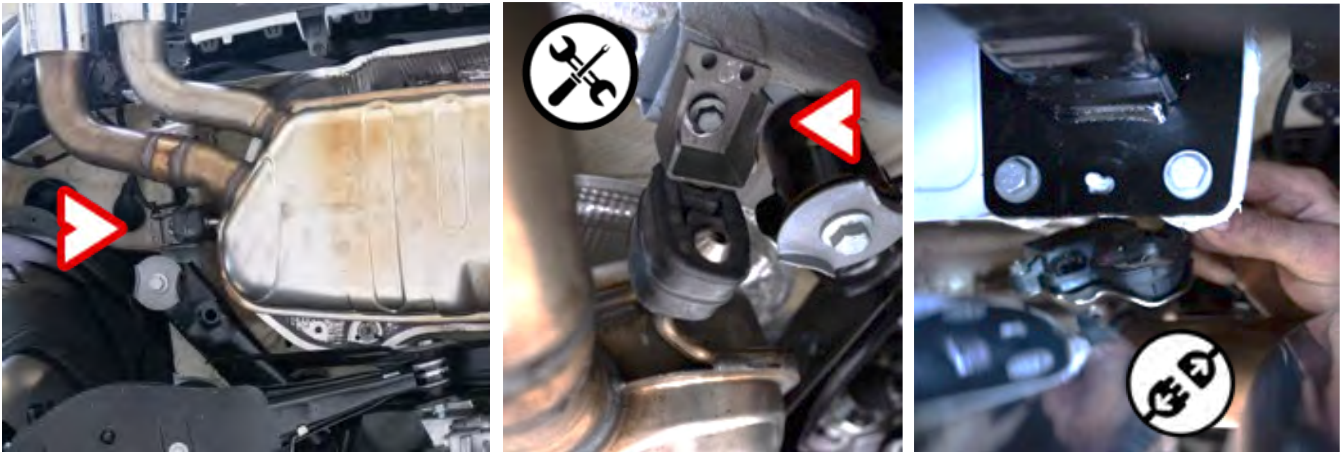

Unhook the rubber hanger and remove the stock rear exhaust.

 **For easier mounting, lubricate the rubber hangers (WD40®).**

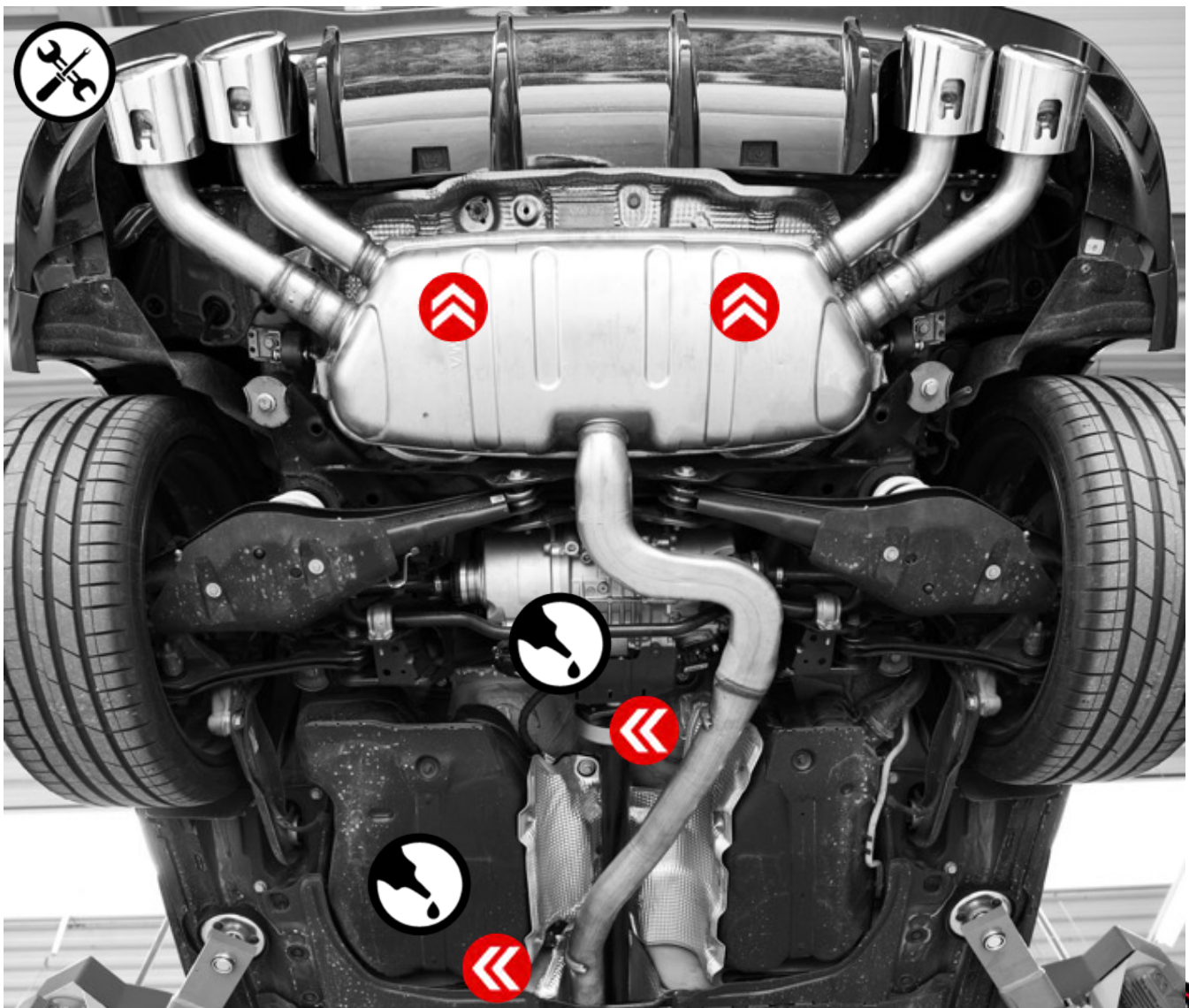

INSTALLATION OF THE REMUS EXHAUST SYSTEM

Unhook the rubber hangers and mount them onto the REMUS supplied brackets.

 **For easier dismounting and mounting, lubricate the rubber supports (WD40®).**

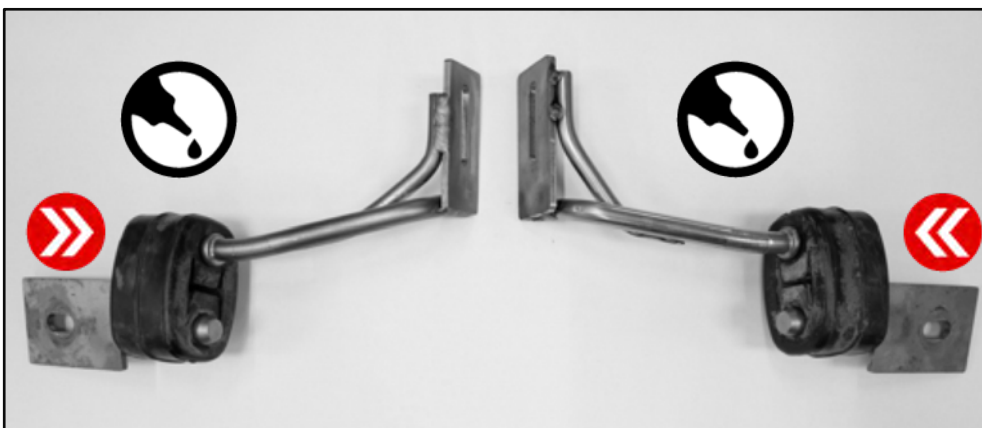
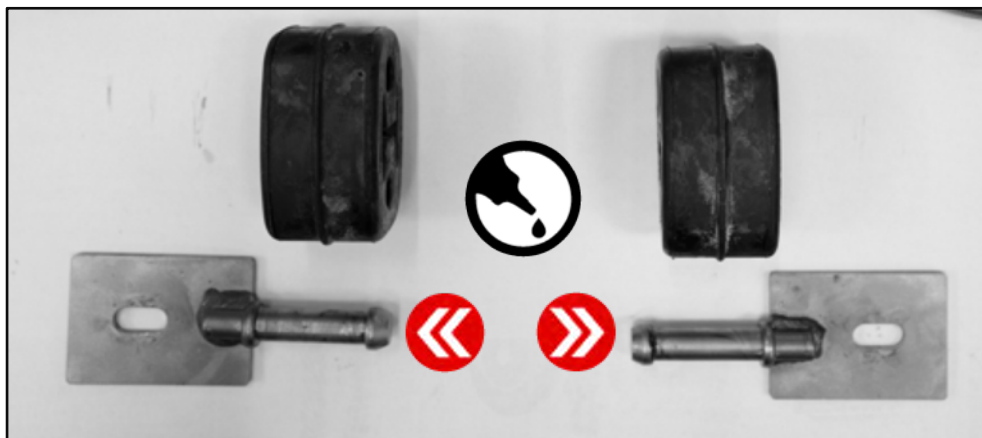

Dismount the actuators from the stock rear exhaust and mount them onto the REMUS valve tubes.



CAUTION: Make sure not to mix the actuators! Put them on the same valves as they were on the stock exhaust system!

IMPORTANT: The springs of the actuators align themselves automatically, suitable for the valves, once a 12V signal (ignition on) is applied. Do not spin the actuator by force!

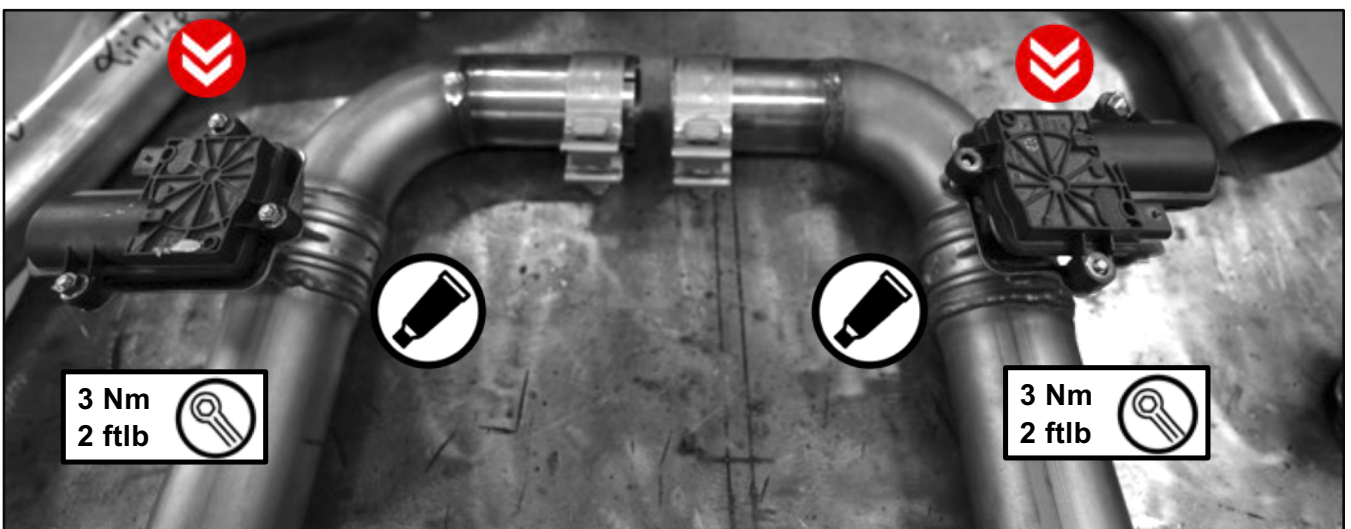
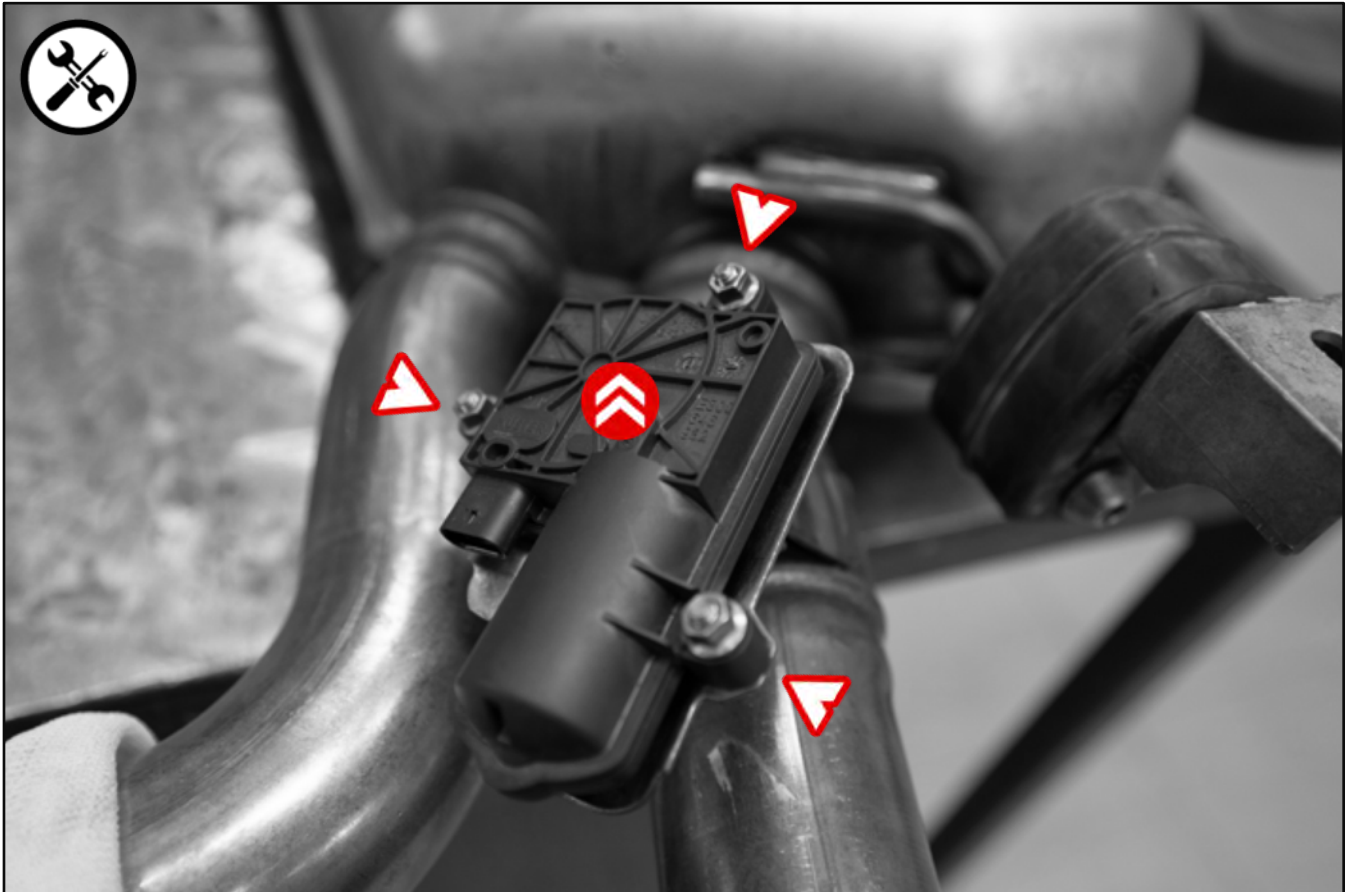

Dismount the stock chassis brackets and mount both REMUS brackets onto the same place.

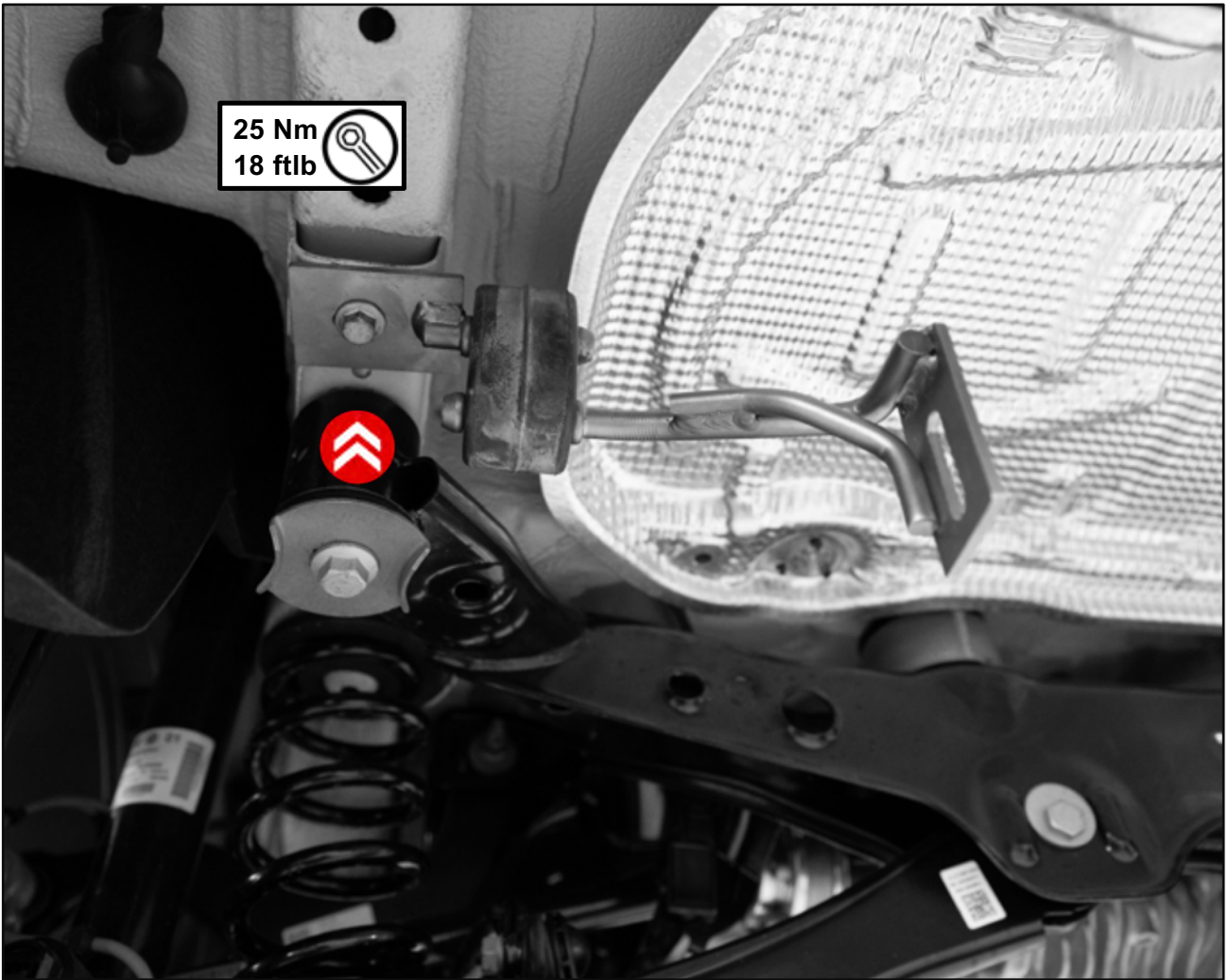

Install the REMUS front tube onto the stock tube.

 **Tighten the clamp only hand-tight!**

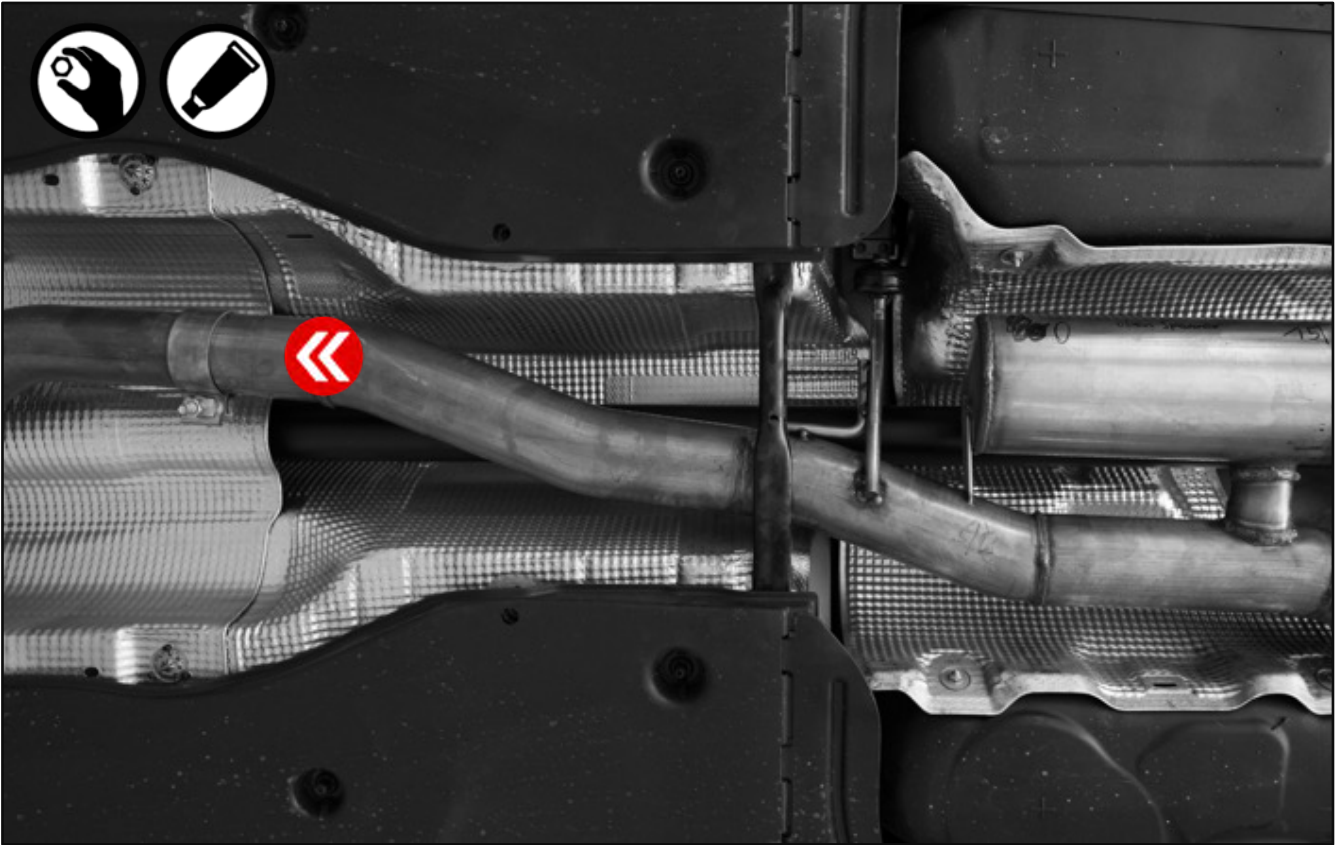

Mount the bracket onto the rubber hanger.

 **For easier mounting, lubricate the rubber hangers (WD40®).**

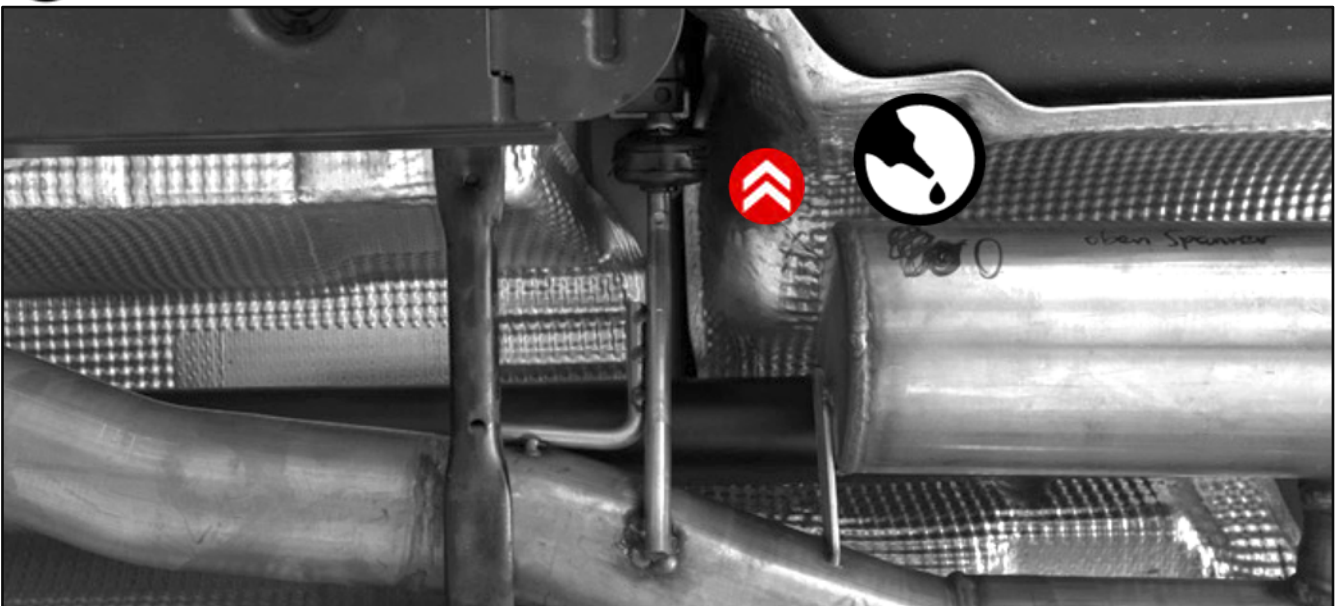

Install the REMUS connection tube onto the REMUS front silencer.

 **Tighten the clamp only hand-tight!**

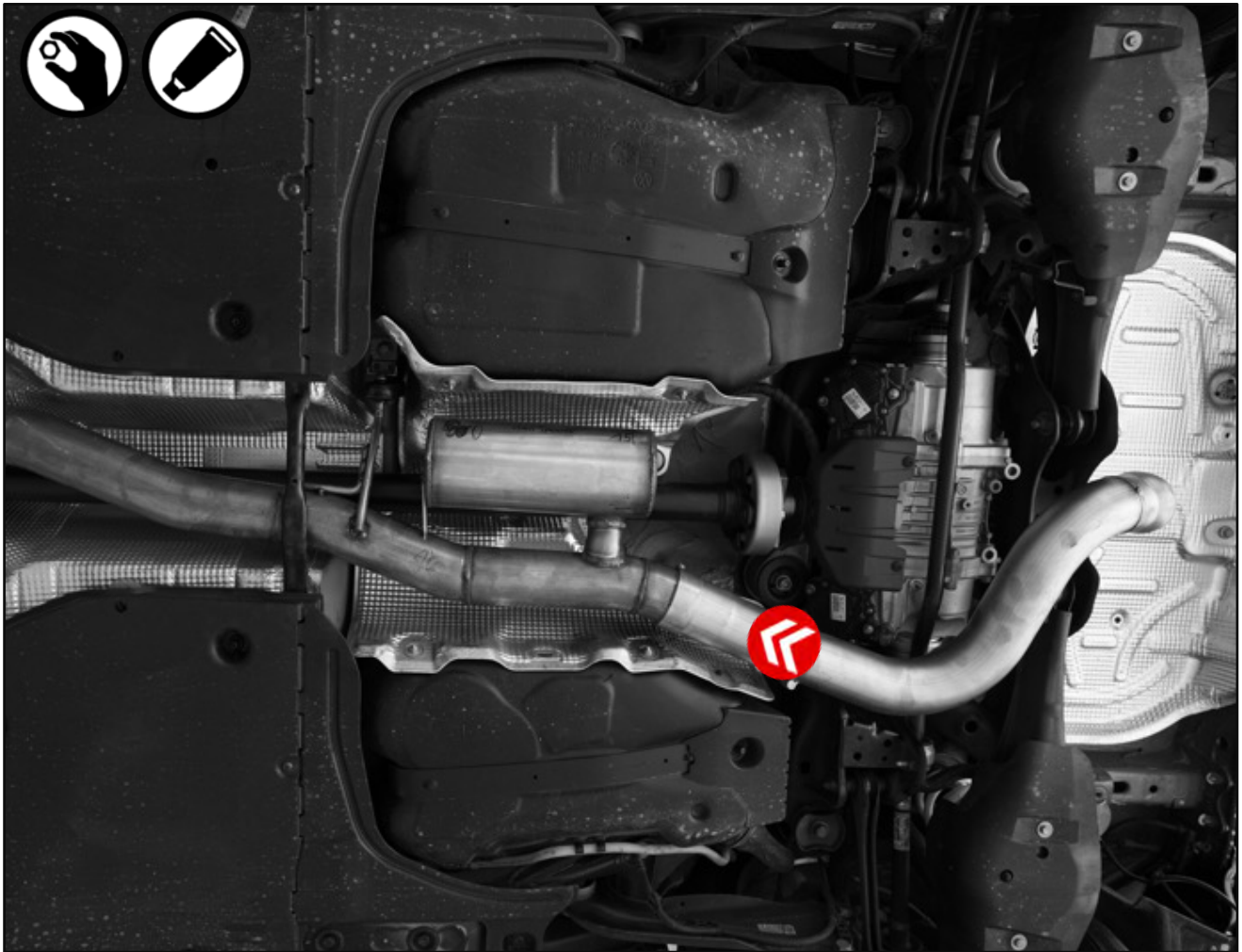

Mount the bracket onto the rubber hanger.

 **For easier mounting, lubricate the rubber hangers (WD40®).**

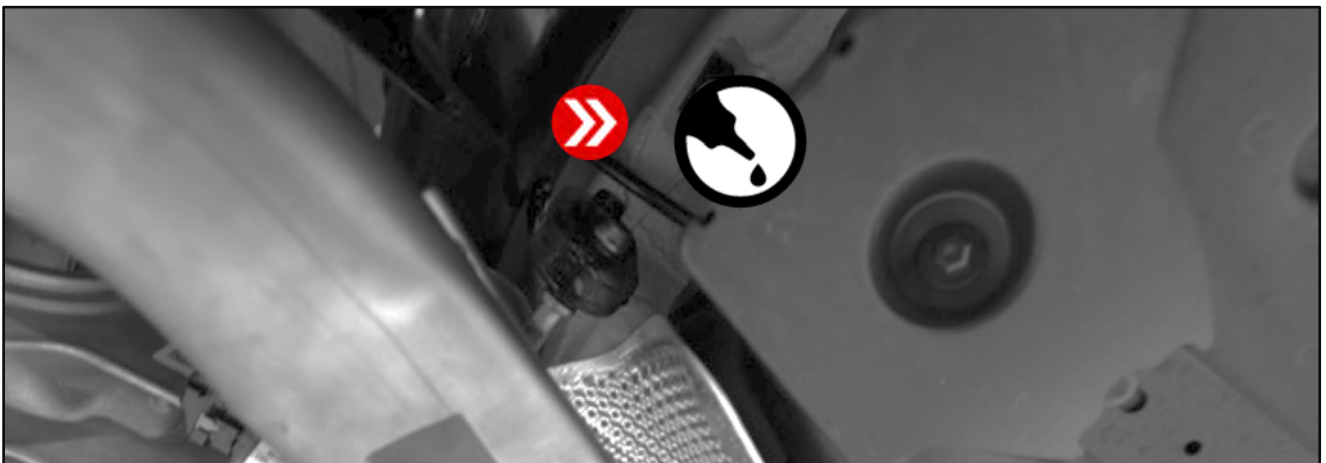

Install the REMUS sport exhaust on the connection tube.

 **Tighten the clamp only hand-tight!**

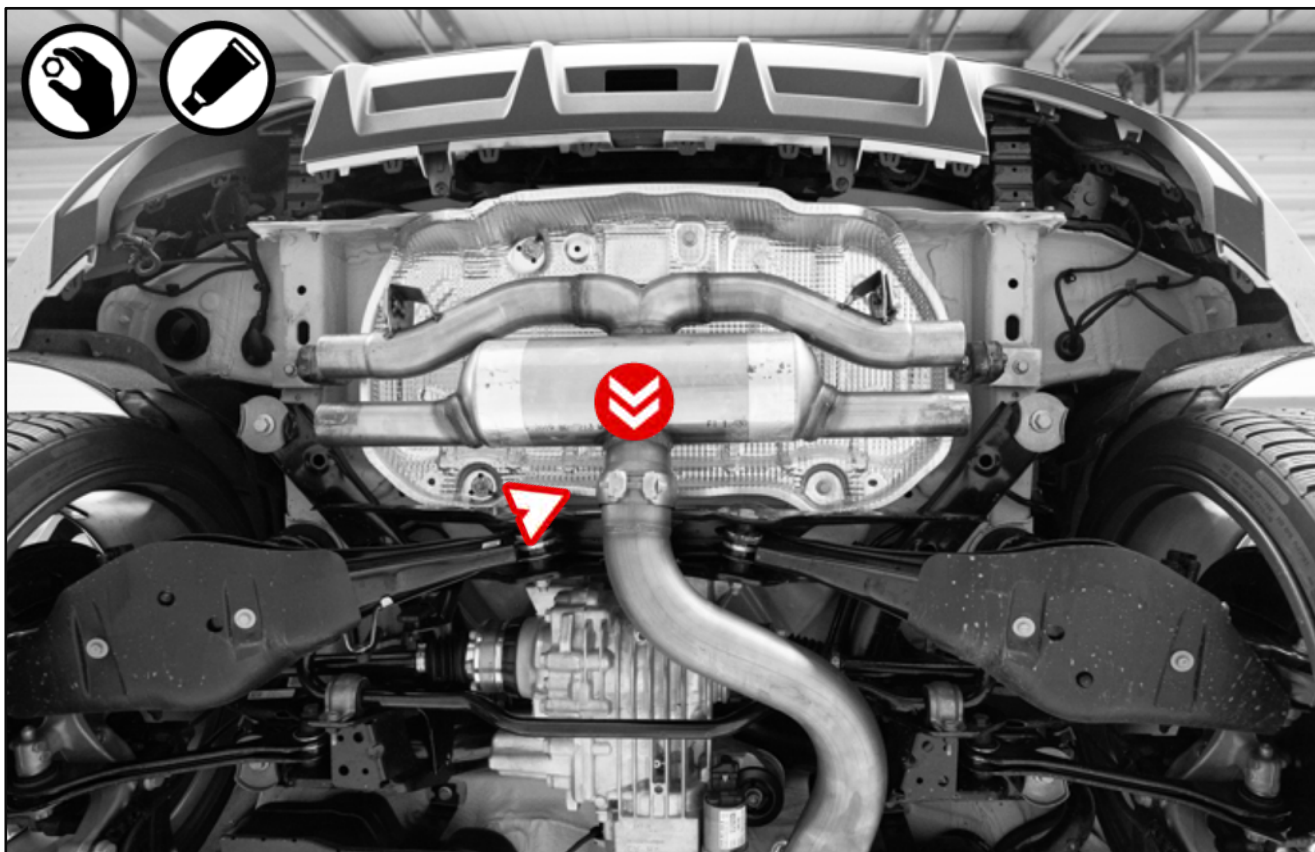

Bolt the previously mounted brackets with the REMUS sport exhaust.

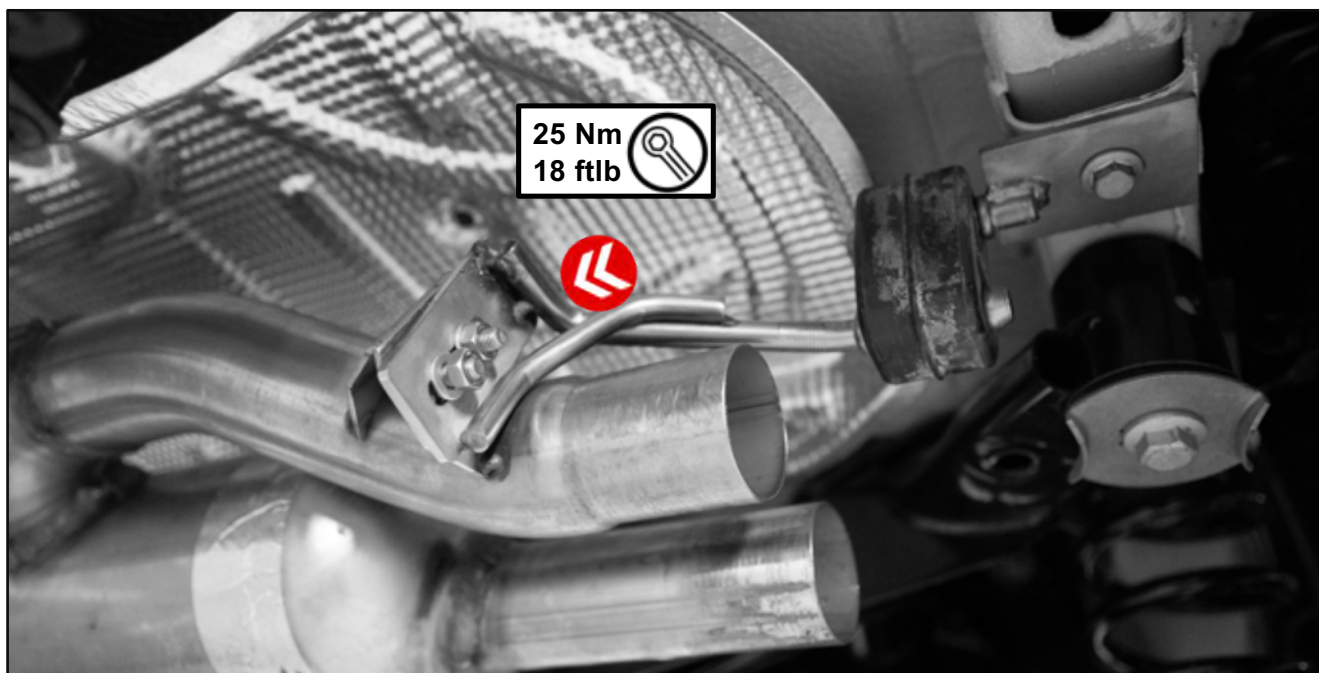

Install the REMUS outlet tubes onto the sport exhaust.

 **Tighten the clamps only hand-tight!**

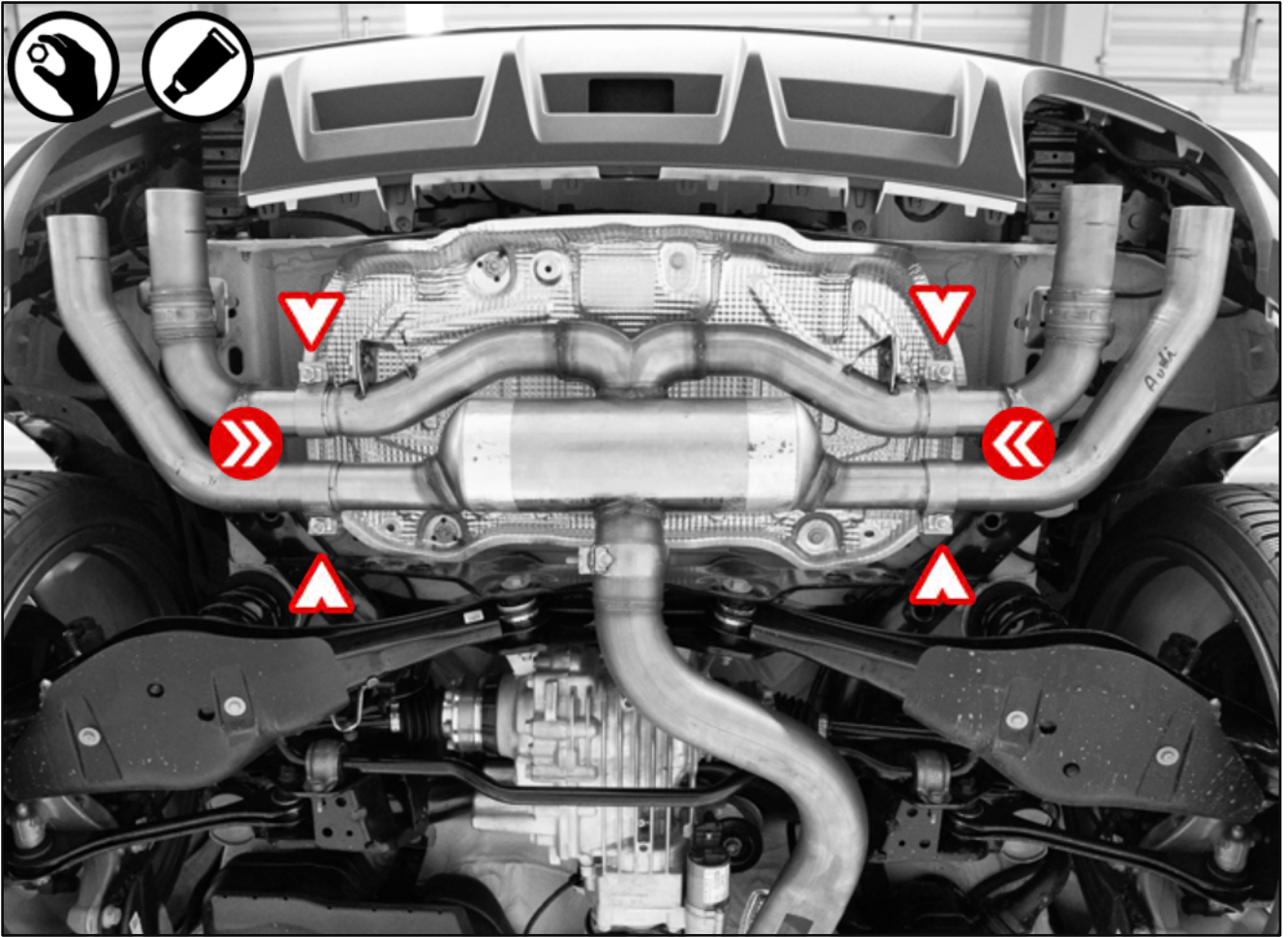

Connect both actuators.



Remount the cross strut.

 **The cross strut must be turned 360° to fit the REMUS tube routing!**

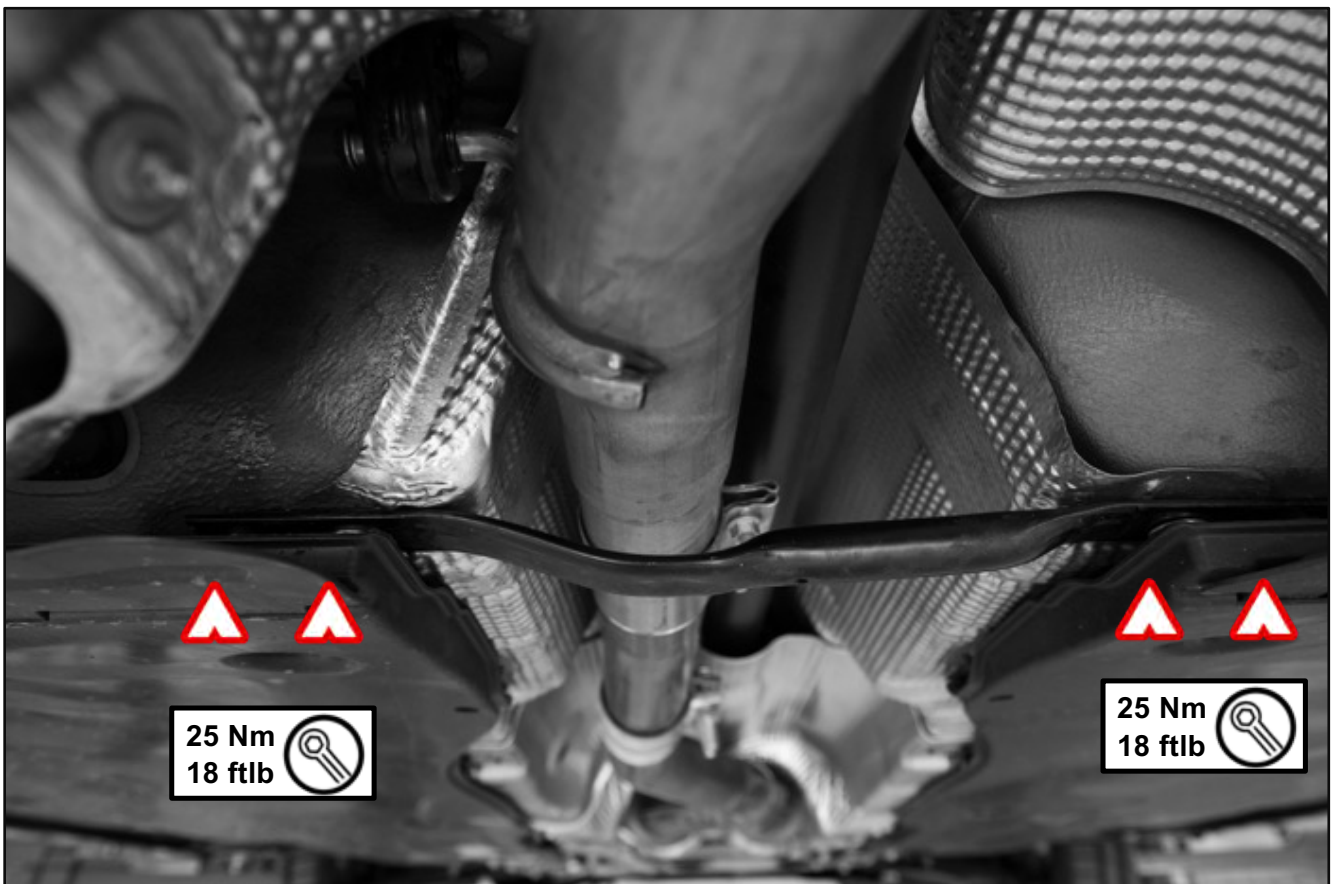
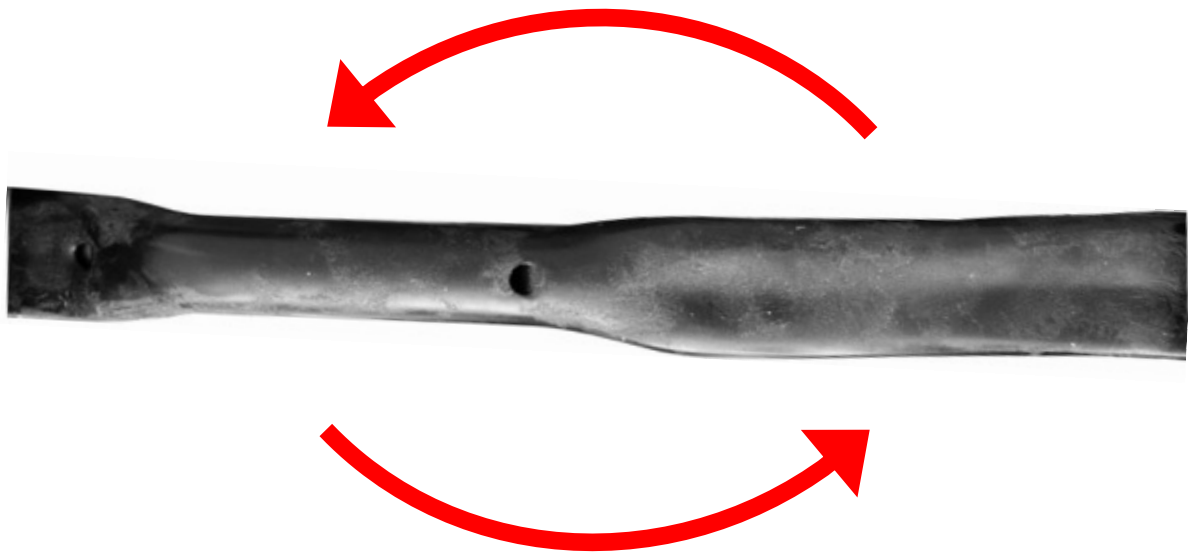

Align the exhaust system and tighten all connections.

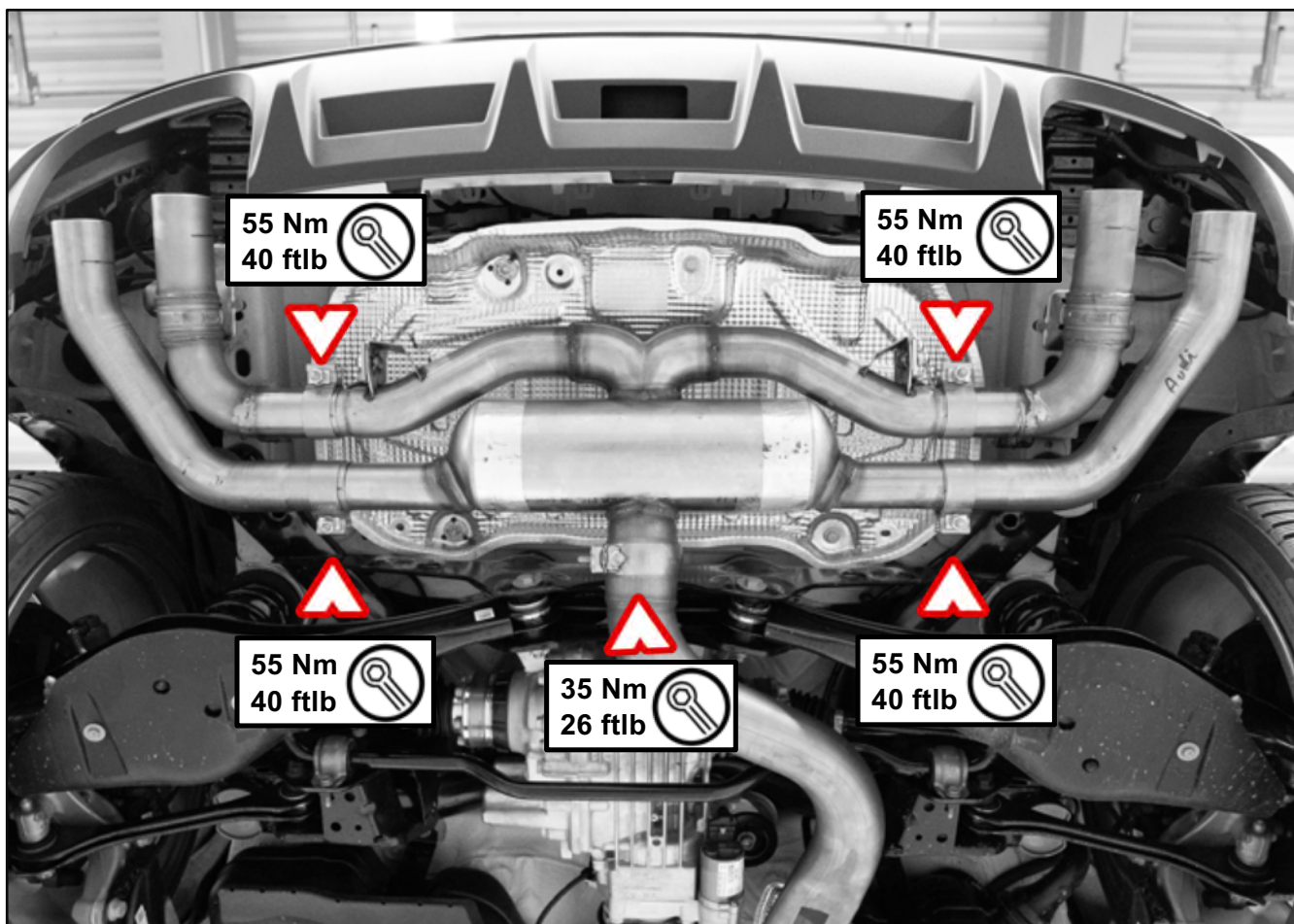
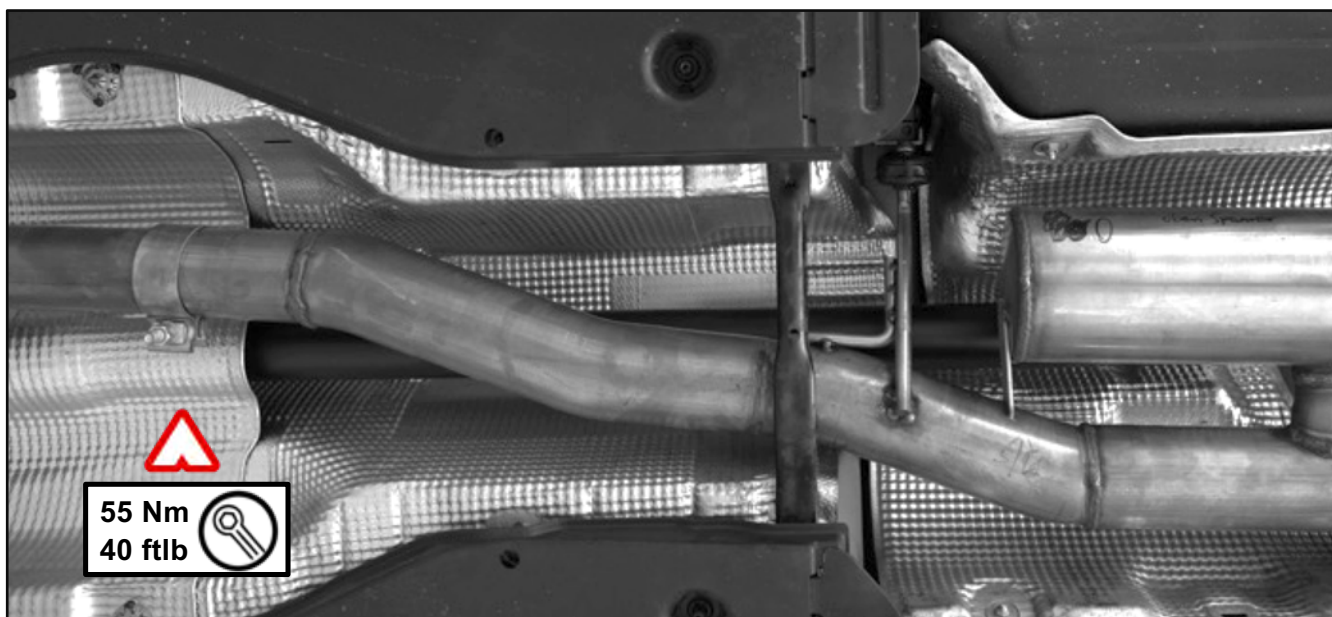

Mount and align the REMUS tailpipes onto the REMUS sport exhaust.

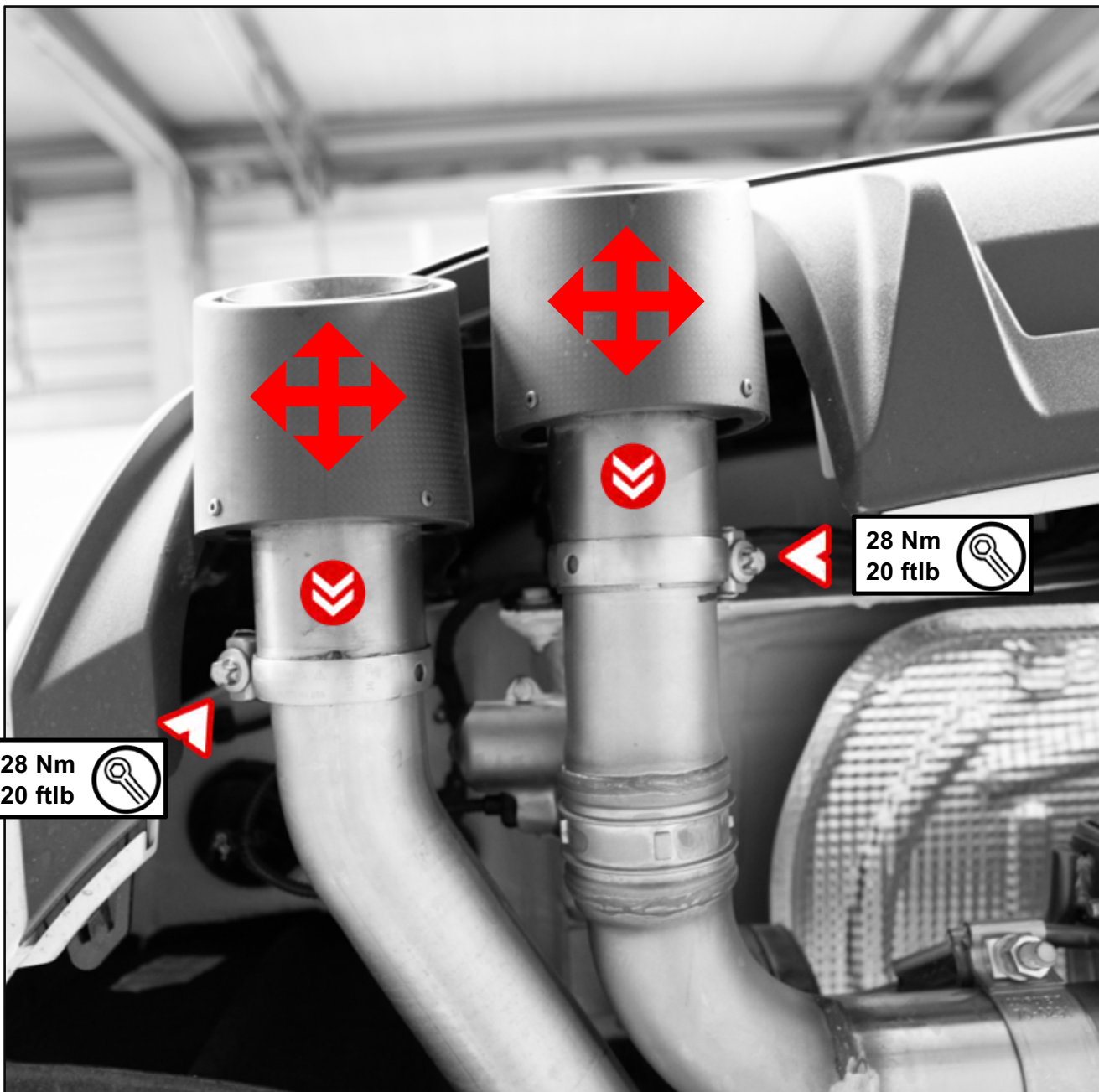

FINAL STEPS

IMPORTANT: reinstall the dismantled or partially removed stock parts (wheel arches, bumper etc.); check vehicle manufacturer manual for tightening torques.

IMPORTANT: make sure all the nuts and bolts are sufficiently tightened. In case the exhaust system touches the cowling or other parts, repeat the adjustment of the exhaust system or contact your authorized dealer.

IMPORTANT: clean all exhaust components before the first start of the engine or the stains will burn onto the surfaces!

TROUBLESHOOTING

Problem	Possible cause	Solution
Exhaust gas is leaking out of the exhaust system	loosened clamp	tighten all connections to specified torque
	connection is not completely joined	loosen the connection and tap it into place, tighten the connection to specified torque
Valve is not working / moving	Valve is mechanical stuck	Remove the actuator and try to move the valve by hand. Use spray lubricant (WD-40® or equivalent) to make the valve working again.
	Valve is not working correct	Make sure the actuator is powered correctly. Make sure the actuator is mounted properly onto the valve and the valve spins correctly.
Exhaust system rattles / doesn't fit properly	Exhaust System is not mounted correct	loosen all connections again and readjust/align the whole system once more



MAINTENANCE

STAINLESS STEEL PARTS:

Clean stainless steel components with soft cloth sprayed with contact cleaner, then wipe with soft and dry cloth.

CARBON PARTS:

Clean carbon fiber exhaust components with soft and dry cloth.

TITANIUM PARTS:

Clean the titanium exhaust components with a multi-purpose spray lubricant (WD-40® or equivalent).

A change in the color of the exhaust system is normal due to high temperatures. Periodically make sure all the bolts and springs are sufficiently tight.



IT IS NORMAL FOR WHITE SMOKE TO COME OUT OF THE MUFFLER AT FIRST OPERATION.



CAUTION: DO NOT STAND BEHIND THE MUFFLER AT ANY TIME.



CAUTION: DO NOT USE AUTOMOTIVE WHEEL CLEANERS OR ANY CLEANING PRODUCTS WHICH CONTAIN ACIDIC ADDITIVES TO CLEAN THE REMUS EXHAUST SYSTEMS.



THE SOUND OF REMUS[®]

FIRST CLASS QUALITY DESIGNED & BUILT IN EUROPE | AUSTRIA

www.remus.eu

 REMUS Innovation GmbH
Ruhmannstraße 11
A-8570 Voitsberg